

Saddlebag Instructions

Please read instructions carefully before installation. We recommend this product be installed by a qualified, and experienced motorcycle technician. If you are unsure of any of the below directions and or your ability to correctly and securely install this product, please contact us or your local dealer for help. Below diagrams show typical installation, your motorcycle may be different so please use diagrams as a guide. Make sure your motorcycle is clean and free from dirt, road grime etc. where the Nelson-Rigg® luggage mounts.

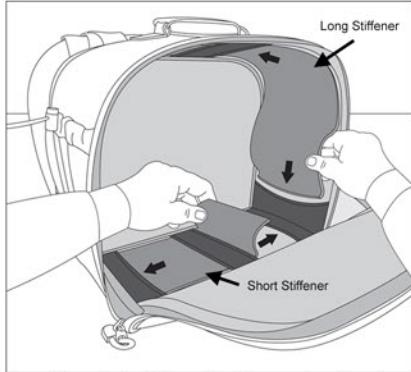

Insert the short stiffener first by passing it under the loop in the base of the bag and tucking ends into the pockets either side of the bottom panel as shown. Next, take the longer stiffener and pass it under the loop in the top of the bag again tucking the ends into the pockets either side of bag as shown. Stiffeners may seem long, but after installed into the the pockets, simply push stiffener into the sides of the saddlebag and it will form the correct and sturdy shape and not collapse.

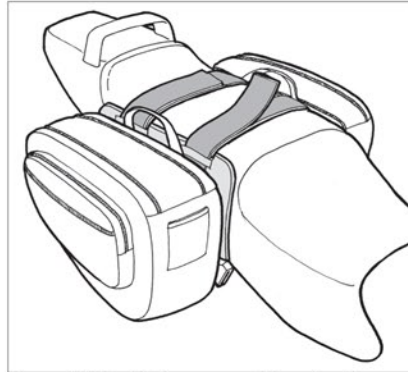

Connect Velcro® straps on each bag together as shown and position over, or if your bike allows, under the seat. Adjust these straps to determine the height of the bags. Further adjustment may be necessary once bags are loaded to ensure they do not come into contact with your exhaust (see diagram below) or moving bike part. For wider vehicles and seats, Velcro® extensions straps can be ordered from our website.

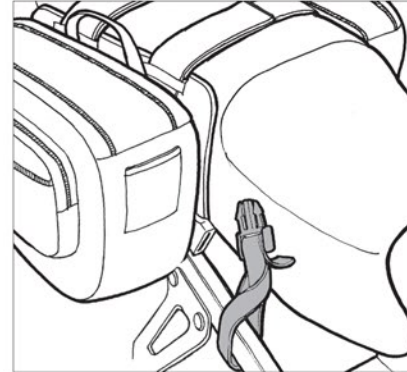

Using the strap with buckle on one side and loop on the opposite side, hook it or loop it around the frame, foot peg or secure body part and then back into the clip on the bag. You can also pass the buckle through the loop creating a noose to attach it around the frame or secure body part.

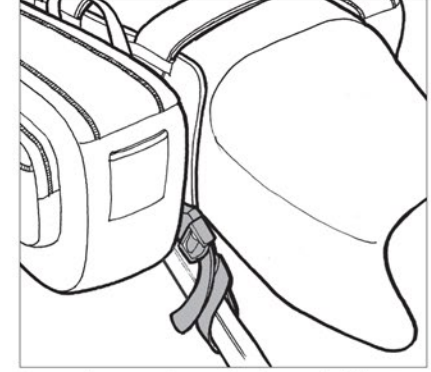

Re-attach strap to bag and adjust to fit. This strap does not need to be overtightened as the side straps mainly hold the bags against the bike only and when installed correctly, do not come under heavy load.

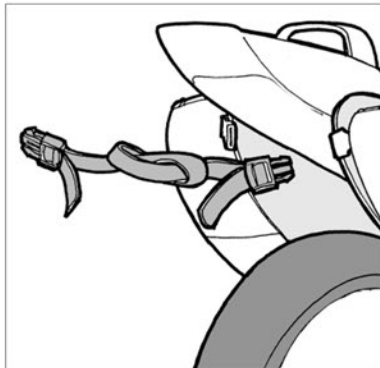

Depending on your bike's configuration, you may have to connect the two bags together with the side straps as shown. Position straps under the fender or licence plate bracket. Do not overtighten. Check the bags from the rear of bike to make sure they are not angled in or out. Bags should be as vertical as possible.

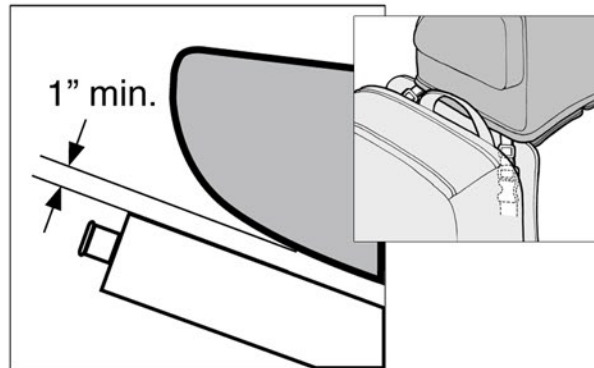

The saddlebags should be positioned with a minimum of 1" clearance above exhaust pipe (see diagram above). Although bottoms of bags have an aluminized heat shield, it will not protect from direct contact with your hot exhaust.

With an optional strap kit, you can attach our tail pack to your saddlebags using the female buckles on the back side between the bags and neoprene pad.

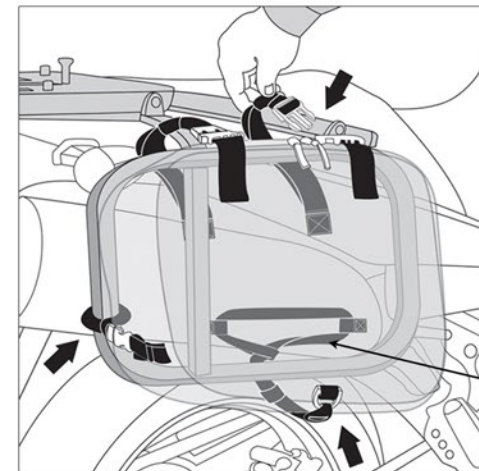

Optional rear Saddlebag Rack Strap

OPTIONAL MOUNTING TO SADDLEBAG RACKS: (CL-855 only)

If your bike has saddlebag racks, you may be able to mount each bag to them independently. Simply unclip the top straps and route the strap with male buckle around the top or the rack and back into the female buckle on the bag. Pull straps tight to secure. Follow the same directions above for the side straps but connect directly to the saddlebag rack. For extra security you can purchase the optional rear saddlebag rack strap and again route around the bottom of the rack and back onto D-ring on the bag. We strongly recommend still using the Velcro straps to connect each saddlebag together that would pass over or under the seat.

Warning:

Read the installation instructions and make yourself familiar with the process of installing the Nelson-Rigg® product(s) on your bike. It is your responsibility to mount the product correctly and securely as outlined in these instructions. Nelson-Rigg® products are intended for use at USA street legal speeds as posted by the individual States. Nelson-Rigg® luggage must not be overloaded. Max carrying capacity is 10 lbs per bag or the maximum load suggested by the manufacturer of the vehicle, whichever is less.

Failure to adhere to these warnings may result in, but not be limited to: the luggage becoming detached, the product becoming tangled in moving parts of the vehicle, unstable vehicle dynamics, reduction in the ability to control the vehicle. The result(s) of could lead to serious injury.

Always ride safely, adhering to the local highway regulations. Always wear a helmet and protective apparel.

3518-A Lake Center Dr Santa Ana, CA 92704
Tel (714)850-1811 Fax (714)850-1848
e-mail: info@nelsonrigg.com www.nelsonrigg.com

